



Product information ELWIST 3008 V

Industrial Connecting Solutions: Circular Connectors: M8 - M12 Connectors: M8 Connectors: M8 Connectors (E series M8): MiniQuick, fast connection, cable plug self-assembled: ELWIST 3008 V

<http://www.e-catalog.beldensolutions.com/link/57078-24228-256281-256292-256303-276518-24247-37239/en/conf/ui/state>

Name	ELWIST 3008 V
	
	Angled cable plug, unassembled, strain relief by means of clamping cage
Delivery informations	
Availability	available
Product description	
Description	Angled cable plug, unassembled, strain relief by means of clamping cage
Type	ELWIST 3008 V
Order No.	933 408-100
Type of contact	male
Number of contacts	3
Cable gland	M 9.5 x 1
Standard	IEC 61076-2-101 (Ed. 1)/ IEC 60947-5-2
Housing Color	black
Technical data	
Pin dimensions	1 mm
Rated voltage	AC/DC 60 V
Rated current	3A (2 A at 0.14 mm ²)
Type of termination	pin penetration
Suitable cables	diameter 4 mm to 5 mm / 0.14 mm ² to 0.34 mm ²
Core insulation of connecting leads	PVC, PETP, diameter 1.0 mm to 1.55 mm
Material	
Contact material	Cu Zn
Contact surface material	Au
Contact bearer material	PA
Housing material	PA
Coupling nut material	Zn Al/Ni
O-Ring	Viton / NBR
Environmental conditions	
Protection class (IEC 60529)	IP 67
Pollution severity	3
Temperature range	-25 °C to +70 °C
Inflammability class	
Housing	94 V-2
Contact bearer	94 V-2
Packing unit	
Packaging unit	100 pieces



HIRSCHMANN

A BELDEN BRAND

Industrial Connecting Solutions: Circular Connectors: M8 - M12 Connectors: M8 Connectors: M8 Connectors (E series M8): MiniQuick, fast connection, cable plug self-assembled: ELWIST 3008 V
<http://www.e-catalog.beldensolutions.com/link/57078-24228-256281-256292-256303-276518-24247-37239/en/conf/ui.state>

Picture
Drawing

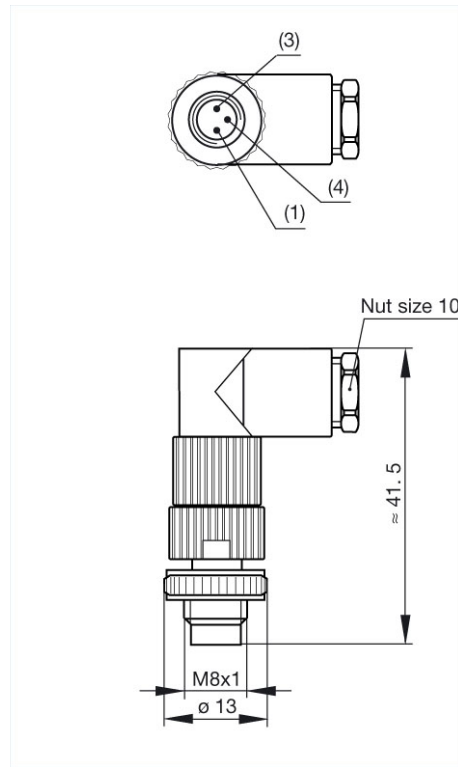

Belden Deutschland GmbH
Im Gewerbepark 2
58579 Schalksmühle
Germany
Phone: +49 7127/14-1806
E-Mail: icos-sales@belden.com

The information published in the websites has been compiled as carefully as possible. It is subject to alteration without notice in technical as well as in price-related/commercial respect. The complete information and data were available on user documentation. Mandatory information can only be obtained by a concrete query.